

AHI



AHI Supply, LP



CAST STONE CATALOG



Dear Industry Professional,

Thank you for requesting our Cast Stone Catalog. AHI Supply, LP is committed to manufacturing quality architectural cast stone products at an affordable price with a focus on *customer satisfaction and service*. Since 1988, AHI has produced a large variety of cast stone products for projects throughout Texas.

- *City Administrative Buildings*
- *Community Centers*
- *Museums, Churches, Hospitals*
- *Schools, Universities, Historical Landmarks, Monuments*
- *And hundreds of Residential Homes have been enhanced with cast stone by AHI Supply, LP*

Your designs are always welcome in our custom shop and our design department is always ready to assist you with your ideas.

Enclosed are over 30 pages of illustrations and specifications available for your review. Should you require an original CADD drawing on CD, please contact us at our nearest location listed below or get in touch with us via our website at www.ahi-supply.com.

We look forward to working with you!

Sincerely,
AHI Supply, LP

AHI's Alvin, Texas Facility - Serving the Houston Area
Office (281)482-8292, (800)873-5794, Fax (281)331-9813

AHI's Buda, Texas Facility - Serving the Austin Area
Office (512)312-0879, (800)499-0984, Fax (512)295-3277

AHI's Roanoke, Texas Facility - Serving the Dallas/Fort Worth Area
Office (817)430-0228, (800)525-5382, Fax (817)430-4370

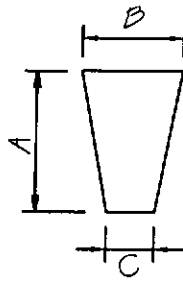

Flat Keystones

ITEM NUMBER	"A"	"B"	"C"	"D"
CSFKEY10D	10"	8"	5"	-
CSFKEY12D	12"	9-1/2"	6"	-
CSCFKEY12D *	12"	9-1/2"	6"	-

* THIS STONE IS CANTED, OR TILTED FORWARD

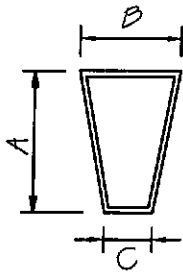

Beveled Keystones

ITEM NUMBER	"A"	"B"	"C"	"D"
CSBKEY6D	6"	2"	2"	-
CSBKEY8D	8"	4"	3"	-
CSBKEY9D	9"	6"	4"	-
CSBKEY10D	10"	8"	5"	-
CSCHKEY10D *	10"	8"	5"	-
CSBKEY12D	12"	10"	6"	-
CSBKEY15D	15"	12-1/2"	7-1/2"	-

* THIS STONE IS CHAMFERED, NOT BEVELED

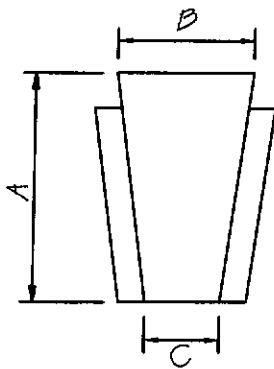

Batwing Keystones

ITEM NUMBER	"A"	"B"	"C"	"D"
CSBWKEY9	9"	6"	4"	-
CSBWKEY11	11"	9"	5-1/2"	-

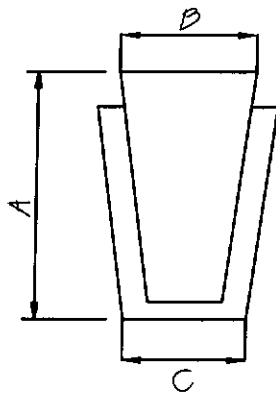

Batwing Keystones

ITEM NUMBER	"A"	"B"	"C"	"D"
CSBWKEY14D	14"	11"	6-3/4"	-
CSCBWKEY14D *	14"	10"	-	-

* THIS STONE IS CANTED, OR TILTED FORWARD

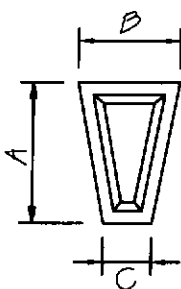

Recessed Keystones

ITEM NUMBER	"A"	"B"	"C"	"D"
CSRKEY10	10"	8"	4"	-
CSRKEY12	12"	9"	5"	-

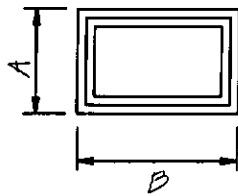

Small Address Stone

ITEM NUMBER	"A"	"B"	"C"	"D"
CSAS10D	9"	14"	—	—
CSAS102D *	9"	14"	—	—
CSAS10DBF	9"	14"	—	—
CSAS102DBF *	9"	14"	—	—

* USED FOR STUCCO- 2" THICK

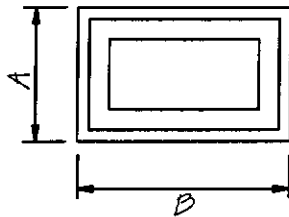

Large Address Stone

ITEM NUMBER	"A"	"B"	"C"	"D"
CSAS20D	11.5"	18.5"	—	—
CSAS202D *	11.5"	18.5"	—	—
CSAS20DBF	11.5"	18.5"	—	—
CSAS202DBF *	11.5"	18.5"	—	—

* USED FOR STUCCO- 2" THICK

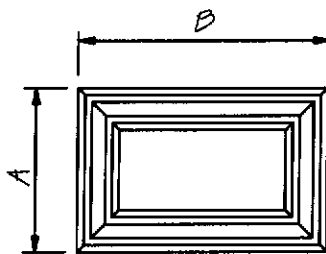

Stepped Address Stone

ITEM NUMBER	"A"	"B"	"C"	"D"
CSASSD	11.75"	18"	—	—
CSASSDBF	11.75"	18"	—	—

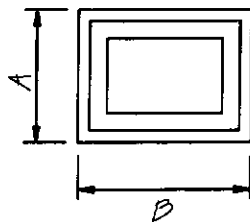

Block Address Stone

ITEM NUMBER	"A"	"B"	"C"	"D"
CSASSTD	11.5"	15"	—	—
CSASSTDBF	11.5"	15"	—	—

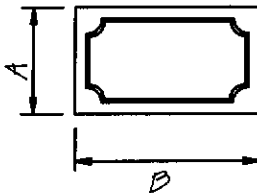

Scalloped Address Stone

ITEM NUMBER	"A"	"B"	"C"	"D"
CSAS30D	9.25"	16"	—	—
CSAS30DBF	9.25"	16"	—	—

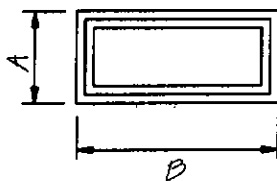

Narrow Address Stone

ITEM NUMBER	"A"	"B"	"C"	"D"
CSAS15D	8"	17.5"	—	—
CSAS15DBF	8"	17.5"	—	—

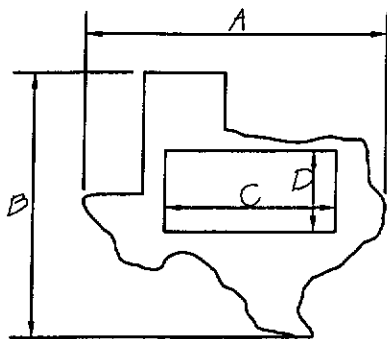

Texas Address Stone

ITEM NUMBER	"A"	"B"	"C"	"D"
CSASTXD	14-3/4"	14-1/2"	9-3/4"	5"
CSASTXDBF	14-3/4"	14-1/2"	9-3/4"	5"

**** Also available without recessed**

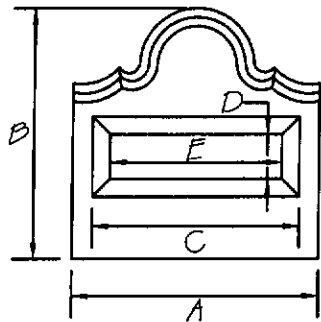

Mission Address Stone

ITEM NUMBER	"A"	"B"	"C"	"D"	"E"
CSASMD	14"	14-1/8"	12"	3"	10-1/2"
CSASMDBF	14"	14-1/8"	12"	3"	10-1/2"

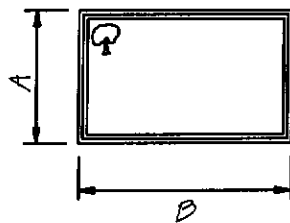

Oak Tree Address Stone

ITEM NUMBER	"A"	"B"	"C"	"D"
CSASOAKD	11.5"	18.5"	-	-
CSASOAKDBF	11.5"	18.5"	-	-

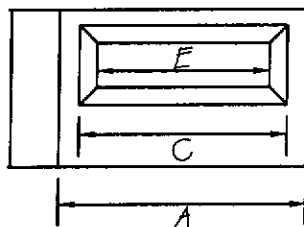

Offset Address Stone

ITEM NUMBER	"A"	"B"	"C"	"D"	"E"
CSASOD	14"	11"	12"	-	10-1/2"
CSASODBF	14"	11"	12"	-	10-1/2"

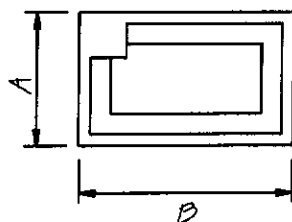

Monogram Address Stone

ITEM NUMBER	"A"	"B"	"C"	"D"
CSASMGD	11.5"	18.5"	-	-
CSASMDBF	11.5"	18.5"	-	-

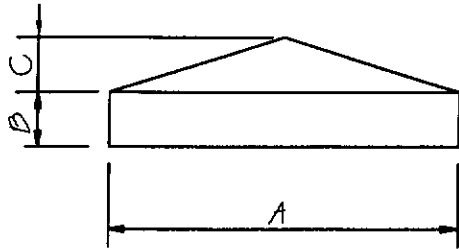

Pyramid Column Caps-Typical Profile

ITEM NUMBER	"A"	"B"	"C"	"D"
CSPT1222	12"	2"	2"	—
CSPT1422	14"	2"	2"	—
CSPT1622	16"	2"	2"	—
CSPT1822	18"	2"	2"	—
CSPT2022	20"	2"	2"	—
CSPT2222	22"	2"	2"	—
CSPT2433	24"	3"	3"	—
CSPT2633	26"	3"	3"	—
CSPT2833	28"	3"	3"	—
CSPT3033	30"	3"	3"	—

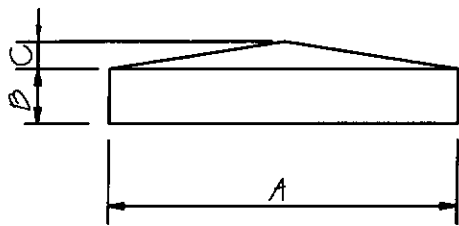

Pyramid Column Caps-Short Profile

ITEM NUMBER	"A"	"B"	"C"	"D"
CSPS1222	12"	2"	1"	—
CSPS1422	14"	2"	1"	—
CSPS1622	16"	2"	1"	—
CSPS1822	18"	2"	1"	—
CSPS2022	20"	2"	1"	—
CSPS2222	22"	2"	1"	—

Note: Use Typical Profile for 24" thru 30"

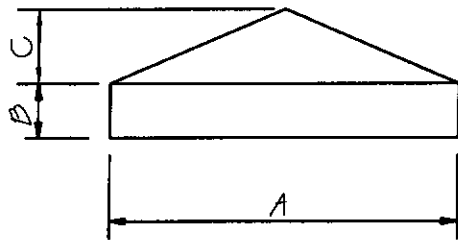

Pyramid Column Caps-Tall Profile

ITEM NUMBER	"A"	"B"	"C"	"D"
CSPTLL1224	12"	2"	4"	—
CSPTLL1424	14"	2"	4"	—
CSPTLL1624	16"	2"	4"	—
CSPTLL1824	18"	2"	4"	—
CSPTLL2024	20"	2"	4"	—
CSPTLL2224	22"	2"	4"	—
CSPTLL2436	24"	3"	6"	—
CSPTLL2636	26"	3"	6"	—
CSPTLL2836	28"	3"	6"	—
CSPTLL3036	30"	3"	6"	—

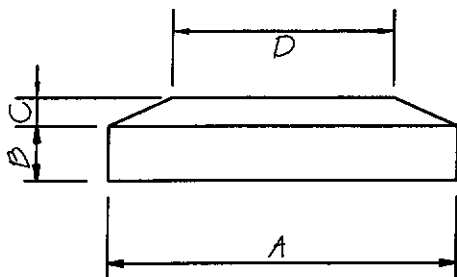

Flat Top Pyramid Caps

ITEM NUMBER	"A"	"B"	"C"	"D"
CSPF1222	12"	2"	2"	—
CSPF1422	14"	2"	2"	—
CSPF1622	16"	2"	2"	—
CSPF1822	18"	2"	2"	—
CSPF2022	20"	2"	2"	—
CSPF2222	22"	2"	2"	—
CSPF2433	24"	3"	3"	—
CSPF2633	26"	3"	3"	—
CSPF2833	28"	3"	3"	—
CSPF3033	30"	3"	3"	—

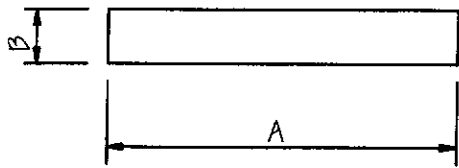

Flat Column Caps

ITEM NUMBER	"A"	"B"	"C"	"D"
CSCF123	12"	3"	—	—
CSCF143	14"	3"	—	—
CSCF163	16"	3"	—	—
CSCF183	18"	3"	—	—
CSCF203	20"	3"	—	—
CSCF223	22"	3"	—	—
CSCF244	24"	4"	—	—
CSCF264	26"	4"	—	—
CSCF284	28"	4"	—	—
CSCF304	30"	4"	—	—

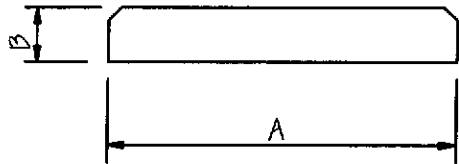

Chamfered Column Caps

ITEM NUMBER	"A"	"B"	"C"	"D"
CSCC123	12"	3"	—	—
CSCC143	14"	3"	—	—
CSCC163	16"	3"	—	—
CSCC183	18"	3"	—	—
CSCC203	20"	3"	—	—
CSCC223	22"	3"	—	—
CSCC244	24"	4"	—	—
CSCC264	26"	4"	—	—
CSCC284	28"	4"	—	—
CSCC304	30"	4"	—	—

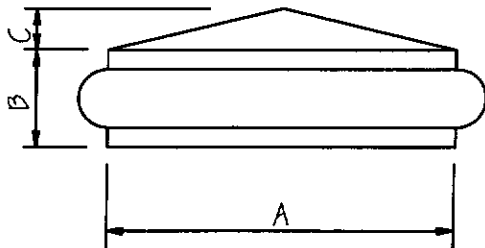

Double Bull Column Cap

ITEM NUMBER	"A"	"B"	"C"	"D"
CSBNC20	20"	3.75"	2"	—
CSBNC24	24"	3.75"	2"	—
CSBNC27	26"	3.75"	2"	—

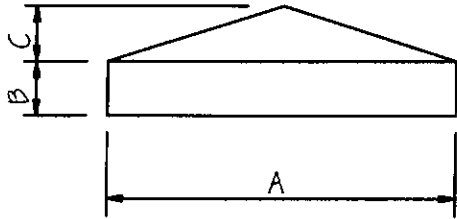

NOTE: "D" = LENGTH

Pyramid Wall Caps

ITEM NUMBER	"A"	"B"	"C"	"D"
CSP51022	10"	2"	2"	36"
CSP51543	15"	4"	3"	25"

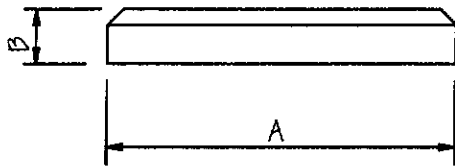

NOTE: "D" = LENGTH

Chamfered Wall Caps

ITEM NUMBER	"A"	"B"	"C"	"D"
CSC2104	10"	4"	-	48"
CSC284	8"	4"	-	48"

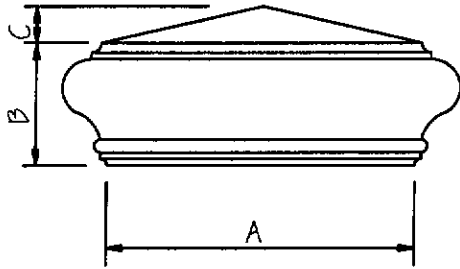

NOTE: "D" = LENGTH

MLD-40 Wall Cap

ITEM NUMBER	"A"	"B"	"C"	"D"
CSML40104	10"	4.75"	2"	42"

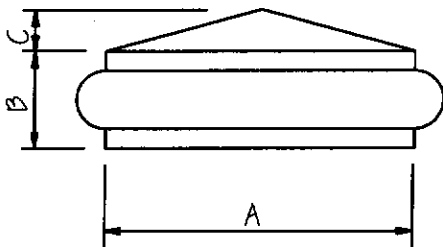

NOTE: "D" = LENGTH

Double Bull Nose Wall Cap

ITEM NUMBER	"A"	"B"	"C"	"D"
CSBN10375	10"	3.75"	2"	42"

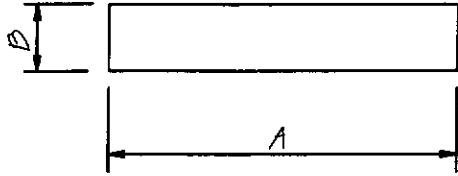

NOTE: "D" - LENGTH

Flat Wall Caps				
ITEM NUMBER	"A"	"B"	"C"	"D"
CSF2104	10"	4"	-	48"
CSF284	8"	4"	-	48"

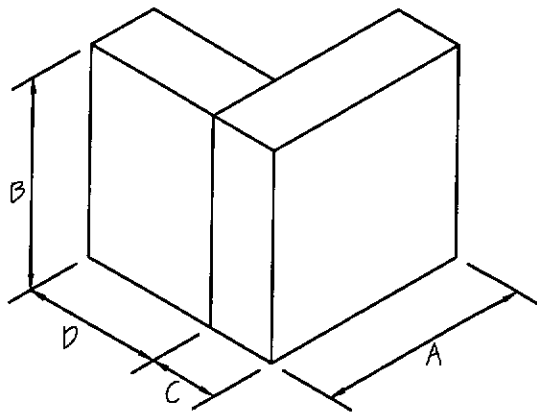

Quoins

ITEM NUMBER	"A"	"B"	"C"	"D"
12"x12"x12"	12"	12"	4"	8"
16"x16"x12"	16"	12"	4"	12"
22"x22"x12"	22"	12"	4"	16"

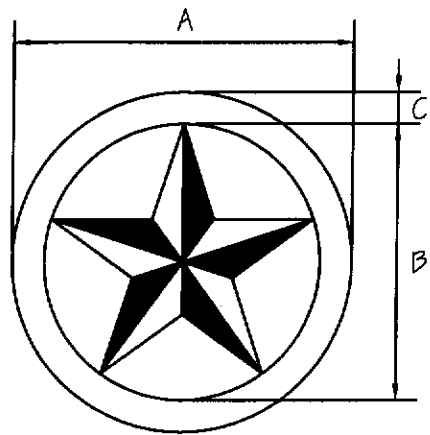

Star

ITEM NUMBER	"A"	"B"	"C"	"D"
CSASS	8"	7"	1"	-
CSASS	16"	13-1/2"	1-1/4"	-
CSASS	32"	26"	3"	-

** Additional sizes available

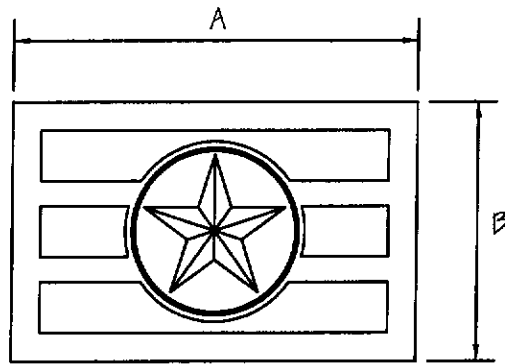

Vent - with star

ITEM NUMBER	"A"	"B"	"C"	"D"
CSVENT	16"	10-1/4"	-	-

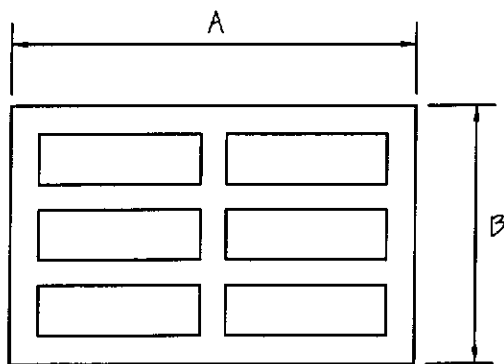

Vent - no star

ITEM NUMBER	"A"	"B"	"C"	"D"
CSVENT	16"	10-1/4"	-	-

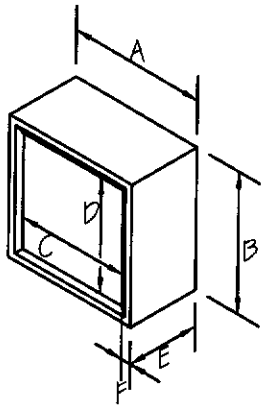

Recessed Plinth

ITEM NUMBER	"A"	"B"	"C"	"D"	"E"	"F"
8"x8"	8"	8"	6-1/2"	6-1/2"	4-1/2"	3-1/4"
8"x12"	8"	12"	6-1/2"	10-1/2"	4-1/4"	3-1/4"
9-3/4"x9-3/4"	9-3/4"	9-3/4"	8-1/4"	8-1/4"	7-3/4"	6-3/4"
12"x12"	12"	12"	10-1/2"	10-1/2"	5-3/4"	4-3/4"

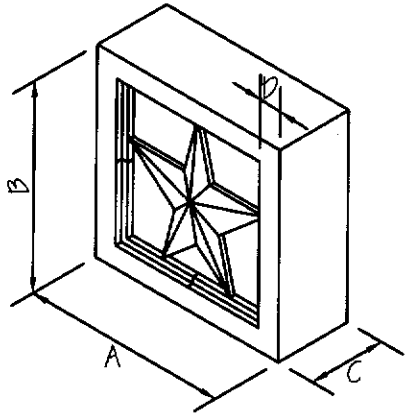

Star Plinth

ITEM NUMBER	"A"	"B"	"C"	"D"
8"x8"	8"	8"	3"	3/4"

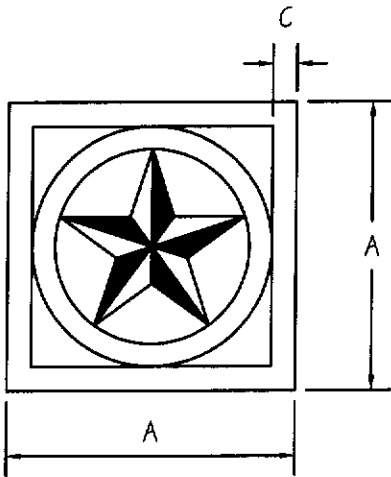

Star Plinth

ITEM NUMBER	"A"	"B"	"C"	"D"
19" x 19"	19"	19"	1-1/2"	

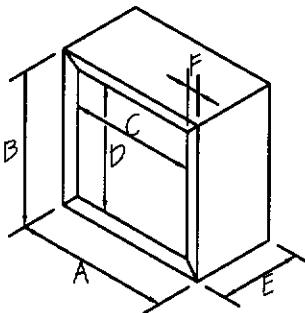

Chamfered Plinth

ITEM NUMBER	"A"	"B"	"C"	"D"	"E"	"F"
8"x8"	8"	8"	6-1/2"	6-1/2"	4-1/4"	3-1/4"
8"x12"	8"	12"	6-1/2"	10-1/2"	4-1/4"	3-1/4"
9-3/4"x9-3/4"	9-3/4"	9-3/4"	8-1/4"	8-1/4"	7-3/4"	6-3/4"
12"x12"	12"	12"	10-1/2"	10-1/2"	5-3/4"	4-3/4"

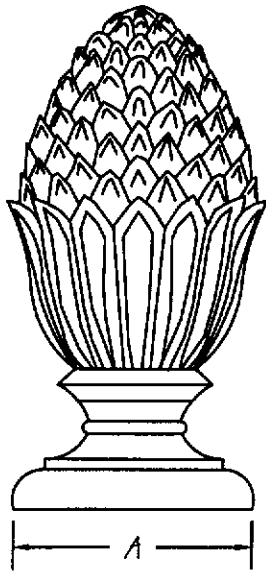

Pineapple Finial					
ITEM NUMBER	"A"	"B"	"C"	"D"	"E"
CSASPF	12"	-	-	-	-

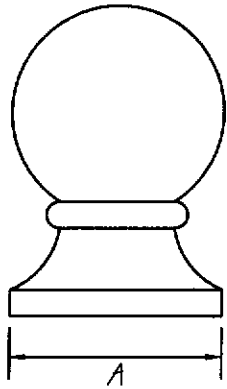

1 1/2 Ball Finial (Round Base)					
ITEM NUMBER	"A"	"B"	"C"	"D"	"E"
CSASBF	12"	-	-	-	-

**** Also available in 8" & 16"**

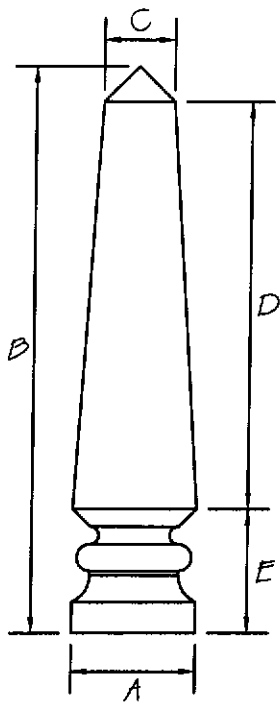

Spire Finial					
ITEM NUMBER	"A"	"B"	"C"	"D"	"E"
CSASSF	7"	23"	4"	14"	7"

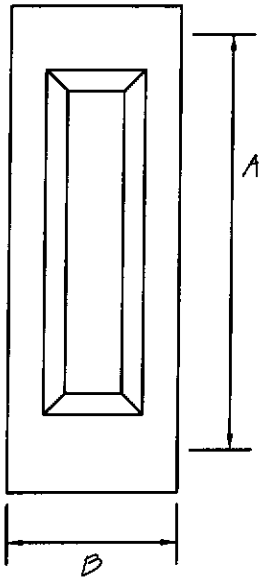

Newel Post					
ITEM NUMBER	"A"	"B"	"C"	"D"	"E"
CSASNP	44"	13"	-	-	-

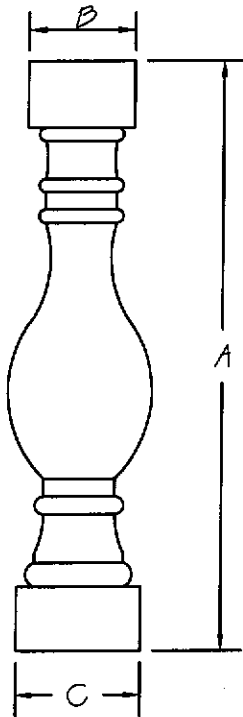

Balustrade #1				
ITEM NUMBER	"A"	"B"	"C"	"D"
CSBAL1	33-3/4"	6"	7"	-

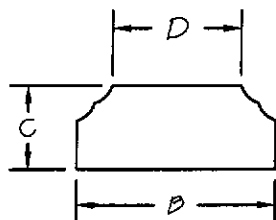
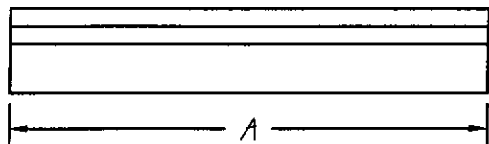

Bases				
ITEM NUMBER	"A"	"B"	"C"	"D"
CSBASE	54"	11-1/4"	4-3/4"	7-5/8"

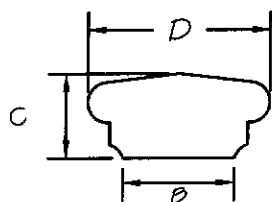
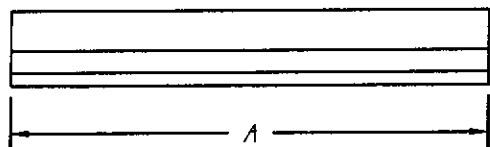
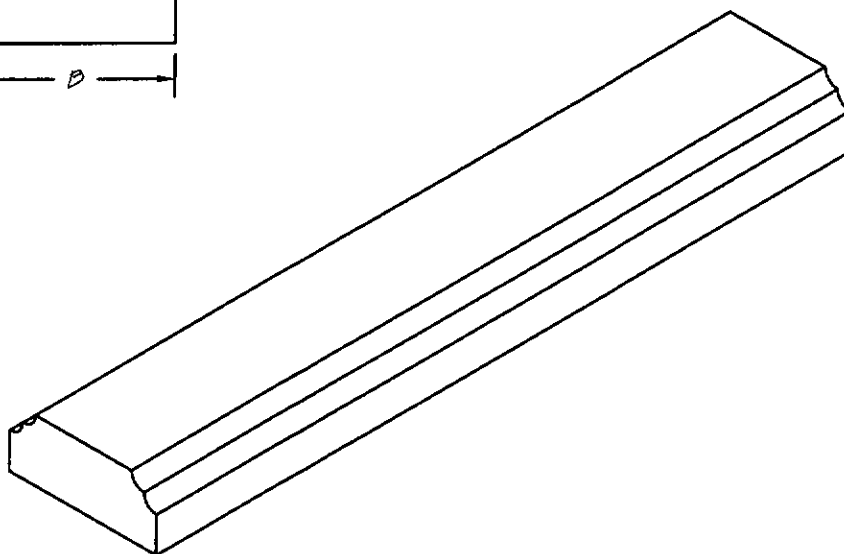

Hand Rail				
ITEM NUMBER	"A"	"B"	"C"	"D"
CSBAL2	54"	4"	9"	12-1/4"

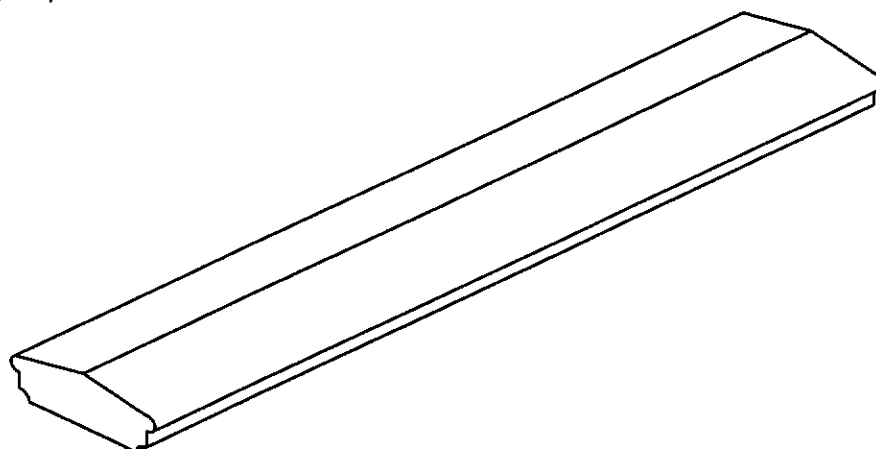

10 Column

ITEM NUMBER	"A"	"B"	"C"	"D"
CSCOL10	Varies	13"	10-3/4"	-

NOTE: MAX HT 10'-2"
MAX VOID 4 1/4"

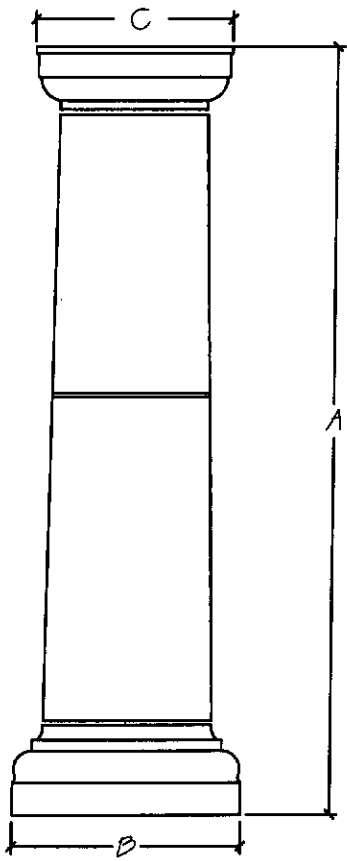

Note: Mortar Joints 3/8"

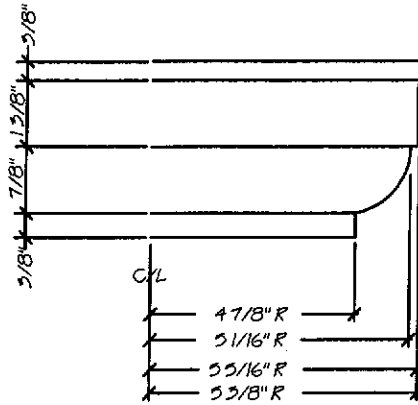

Cap Detail

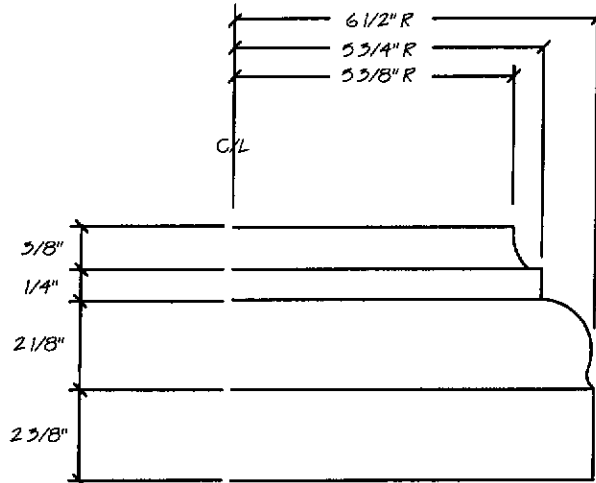

Base Detail

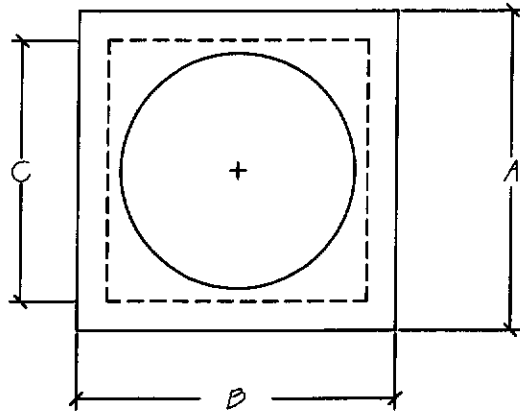

Note: Mortar Joints 3/8"

12 Column				
ITEM NUMBER	"A"	"B"	"C"	"D"
CSCOL12	Varies	16-1/2"	-	-

NOTE: MAX HT. 11'-4"
 INSIDE MAX VOID: 5-1/2" RD

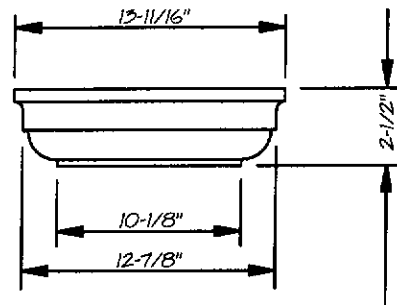
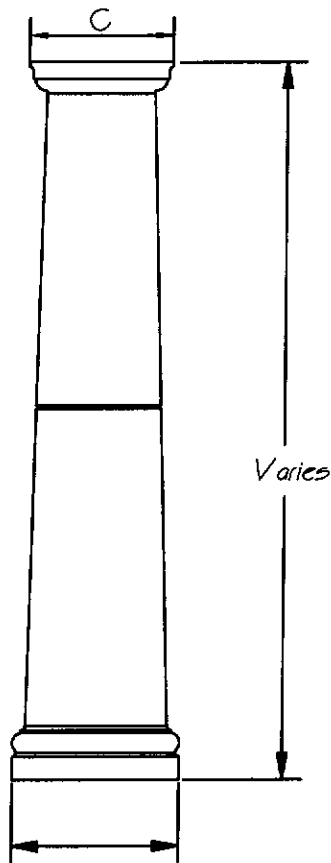

COLUMN CAP DETAIL

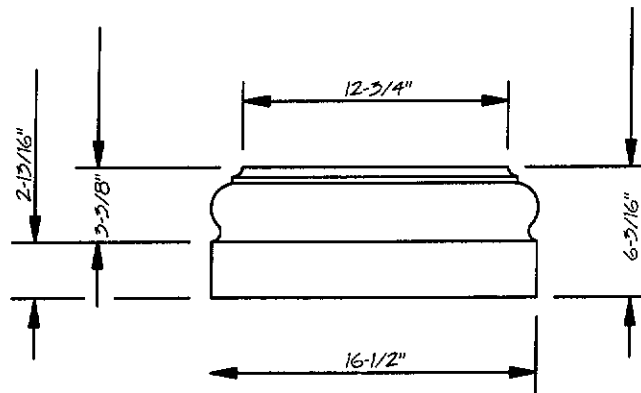

COLUMN BASE DETAIL

16 Column

ITEM NUMBER	"A"	"B"	"C"	"D"
CSCOL16	Varies	21-3/4"	19-1/16"	-

NOTE: MAX HT. 11'-1 3/4"

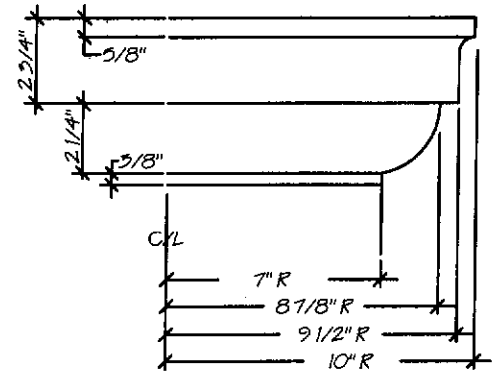
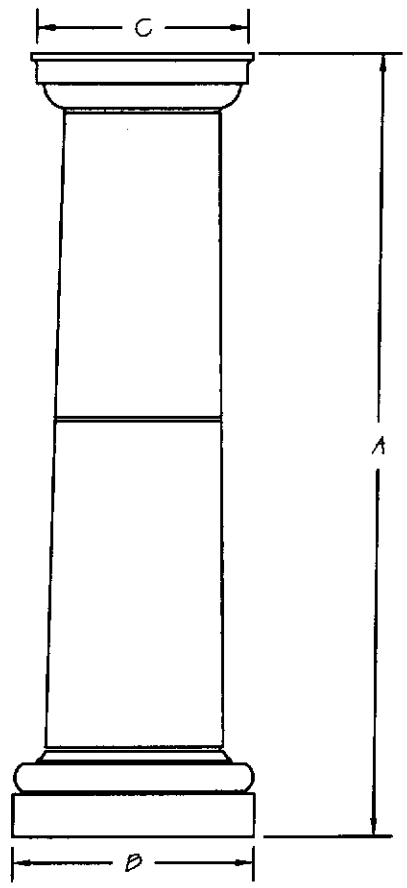

Cap Detail

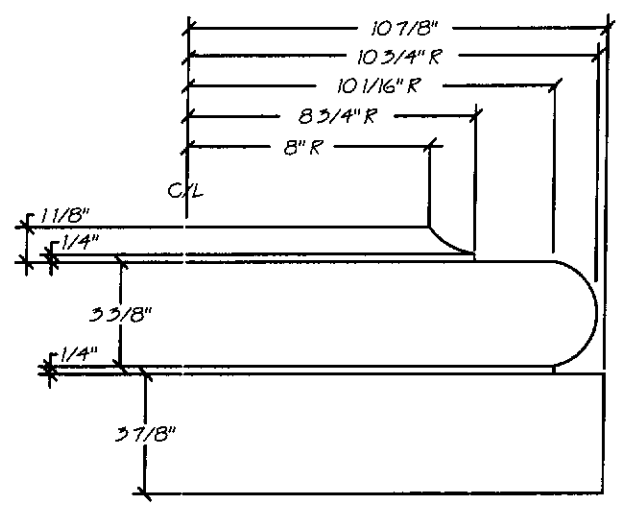

Base Detail

Note: Mortar Joints 3/8"

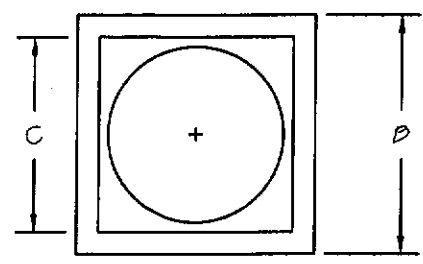

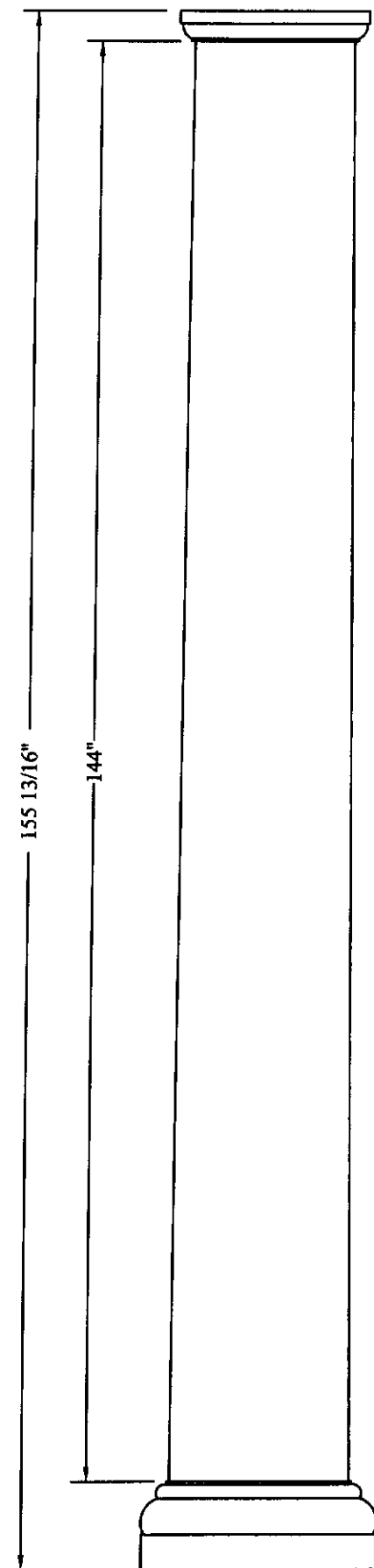

18 Column

ITEM NUMBER	"A"	"B"	"C"	"D"
CSCOL18	Varies	23-1/2"	19-1/16"	-

NOTE: NO MAX HT.
MAX VOID: 12" RD

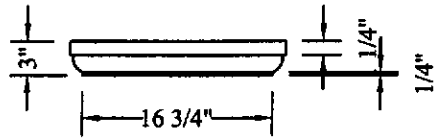

Cap Detail

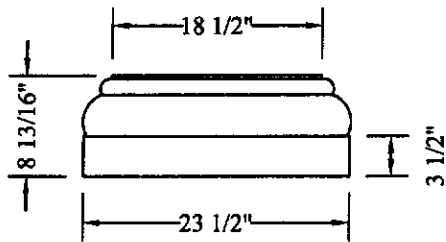

Base Detail

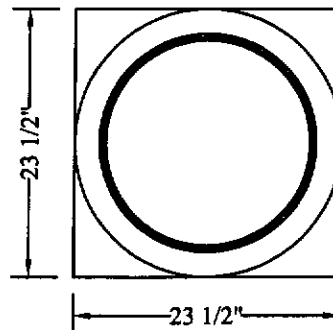

Note: Mortar Joints 3/8"
www.dhi-supply.com

24 Column

ITEM NUMBER	"A"	"B"	"C"	"D"
CSCOL24	Varies	29-1/2"	25-3/4"	-

NOTE: MAX HT. 12'-0"
MAX VOID: 17'-1/4" RD

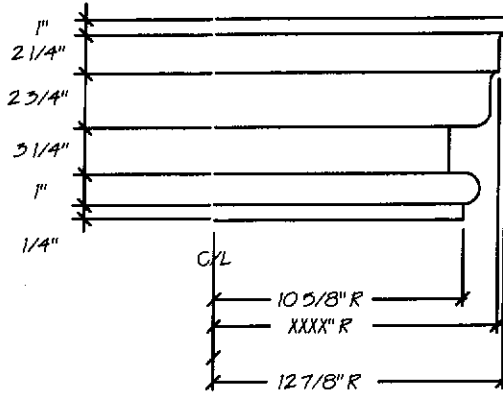
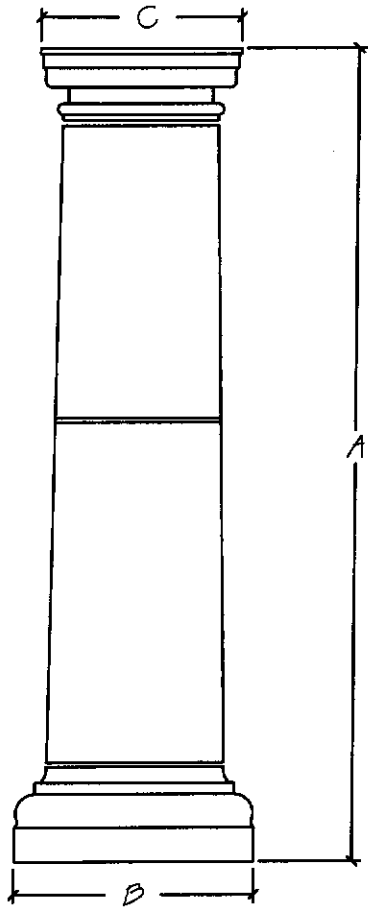

Cap Detail

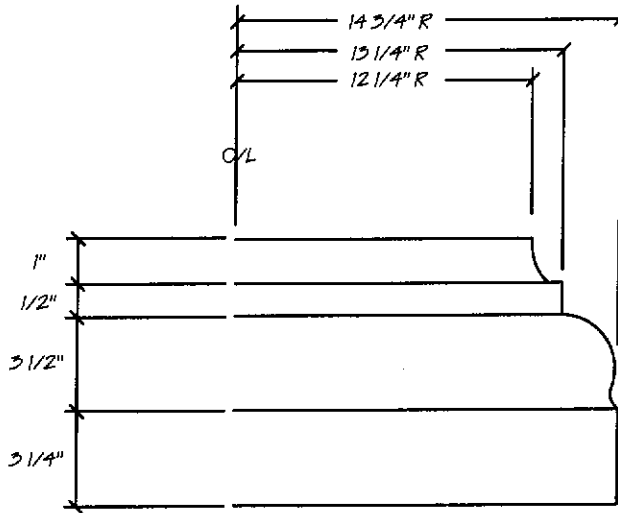

Base Detail

Note: Mortar Joints 3/8"

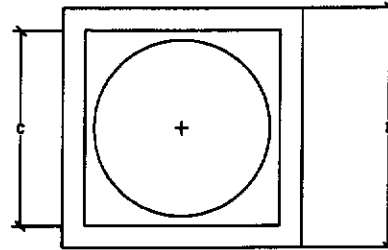

23 Waterford Column (Square)

ITEM NUMBER	"A"	"B"	"C"	"D"
CSWCOL23	Varies	23"	10-3/4"	18"

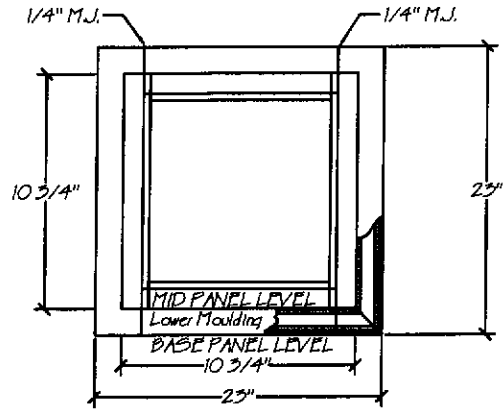
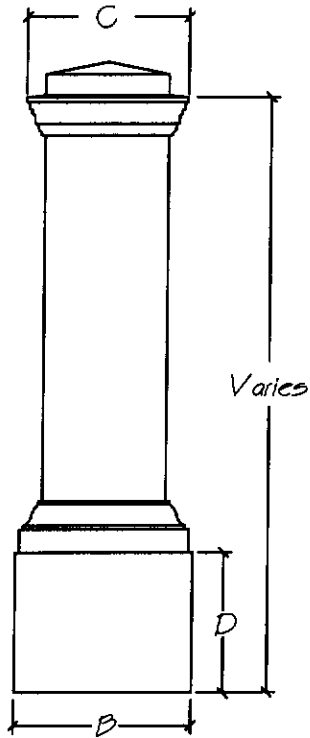

COLUMN CUTAWAY BELOW UPPER MOULDING

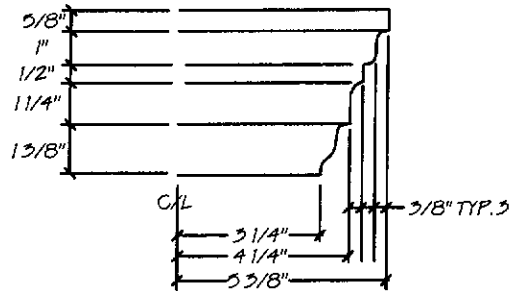

COLUMN CAP DETAIL

Note: Mortar Joints 3/8"

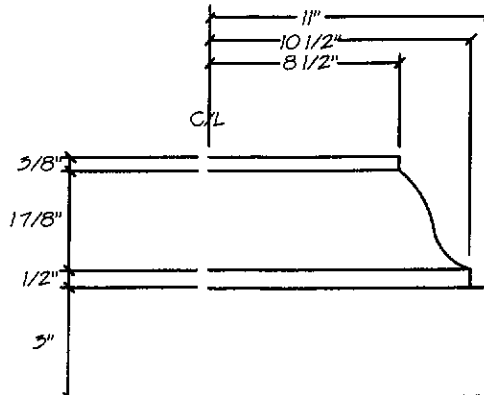

COLUMN BASE DETAIL

30 Waterford Column (Square)

ITEM NUMBER	"A"	"B"	"C"	"D"
CSWCOL30	Varies	30"	17"	18"

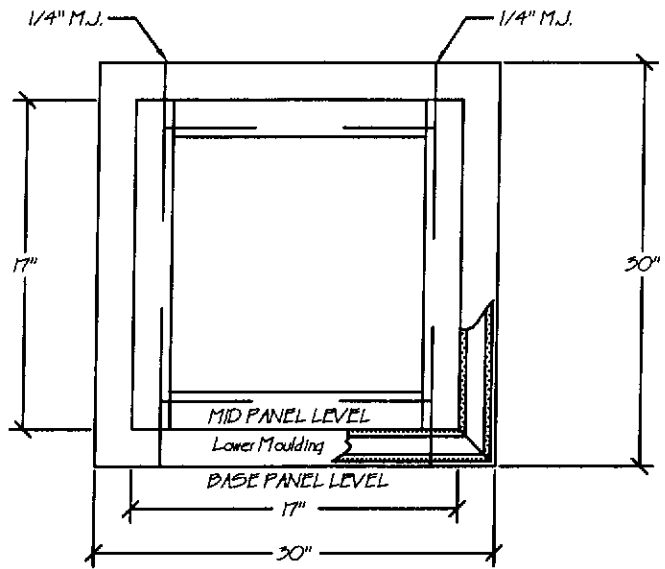
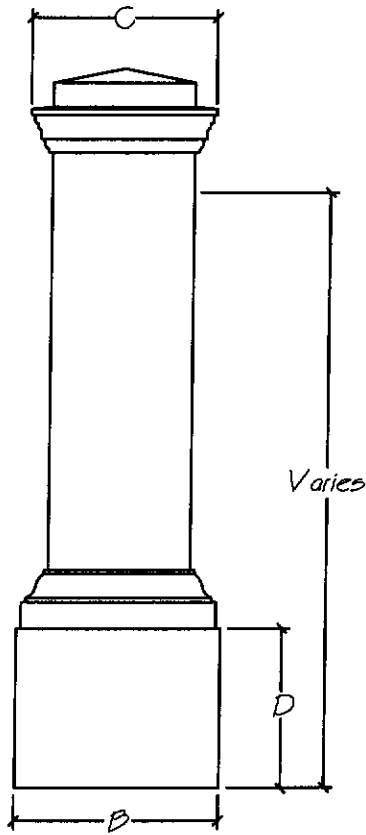

COLUMN CUTAWAY BELOW UPPER MOULDING

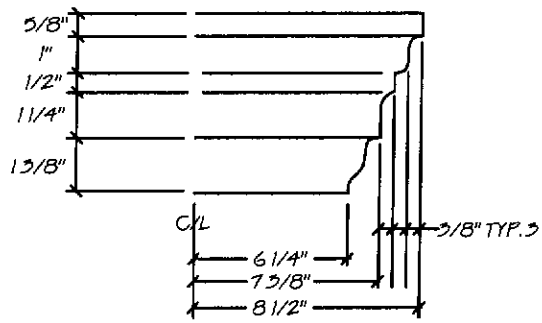

COLUMN CAP DETAIL

Note: Mortar Joints 3/8"

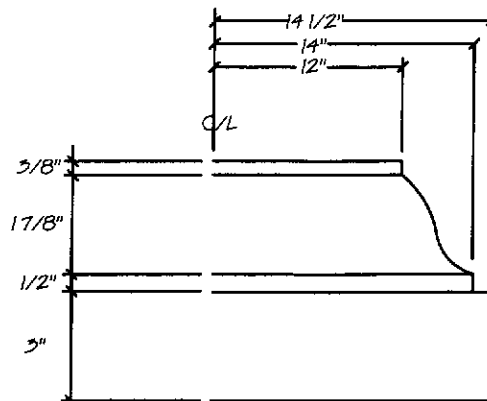

COLUMN BASE DETAIL

Dusenbury (Fireplace)

ITEM NUMBER	"A"	"B"	"C"	"D"
CSFPDB	-	-	-	-

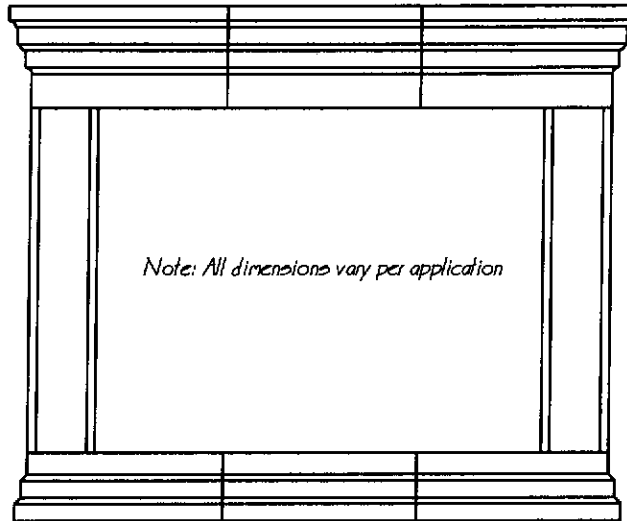

Edward 1 (Fireplace)

ITEM NUMBER	"A"	"B"	"C"	"D"
CSFPED1	-	-	-	-

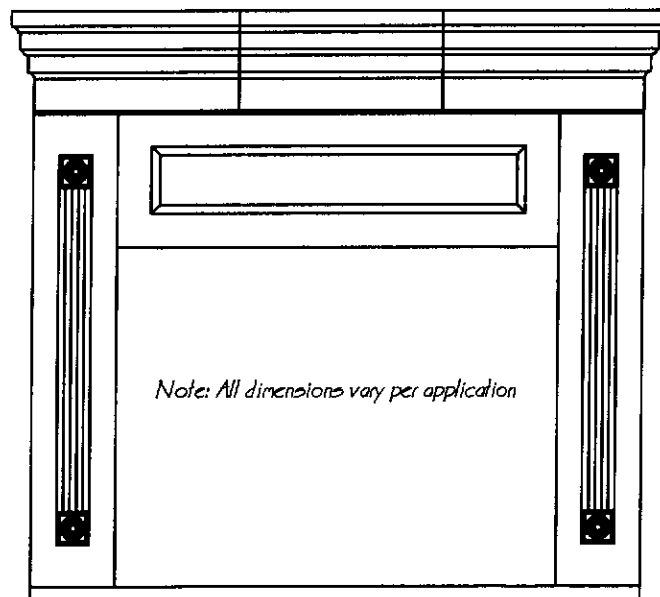

Note - Virtually every molding profile we offer is available in lengths up to 36 inches.
 Also, every profile has been replicated in many different radii for arched applications such as window surrounds and entries.

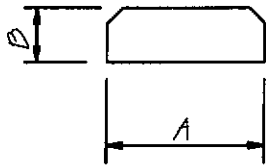

MLD-10 Molding

ITEM NUMBER	"A"	"B"	"C"	"D"
CSML1064	6"	4"	-	36"
CSML1084	8"	4"	-	36"

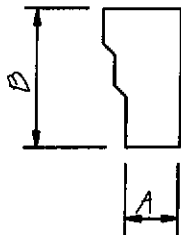

MLD-20 Molding

ITEM NUMBER	"A"	"B"	"C"	"D"
CSML2084	4"	8"	-	36"

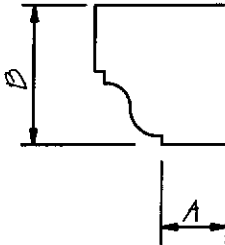

MLD-30 Molding

ITEM NUMBER	"A"	"B"	"C"	"D"
CSML30735	3-5/8"	6-3/4"	-	36"

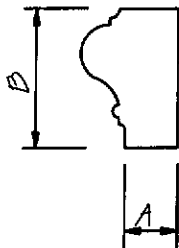

MLD-40 Molding

ITEM NUMBER	"A"	"B"	"C"	"D"
CSML4063	3"	6"	-	36"

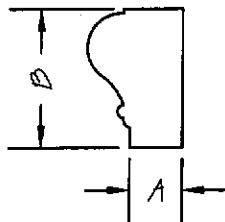

MLD-45 Molding

ITEM NUMBER	"A"	"B"	"C"	"D"
CSML4584	4"	8"	-	36"

Note - Virtually every molding profile we offer is available in lengths up to 36 inches.
 Also, every profile has been replicated in many different radii for arched applications such as window surrounds and entries.

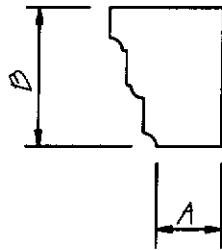

MLD-50 Molding

ITEM NUMBER	"A"	"B"	"C"	"D"
CSML508475	4-1/2"	8"	-	Varies

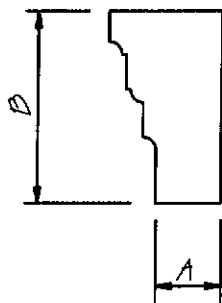

MLD-55 Molding

ITEM NUMBER	"A"	"B"	"C"	"D"
CSML5512475	4-3/4"	12"	-	Varies

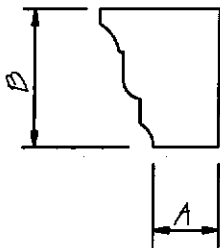

MLD-65 Molding

ITEM NUMBER	"A"	"B"	"C"	"D"
CSML6564	4"	6"	-	Varies

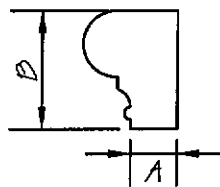

MLD-70 Molding

ITEM NUMBER	"A"	"B"	"C"	"D"
CSML7064	4"	6"	-	Varies

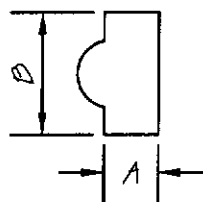

MLD-75 Molding

ITEM NUMBER	"A"	"B"	"C"	"D"
CSML7544	4"	4"	-	Varies

Belaire Entry

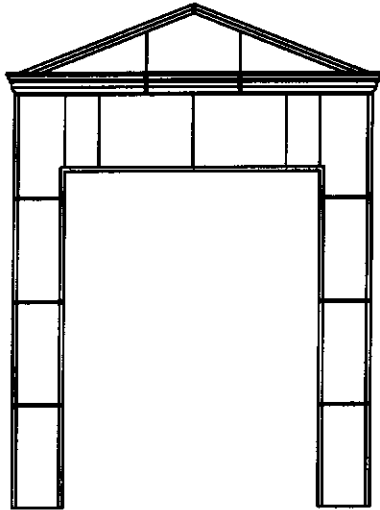

Bentwater Entry

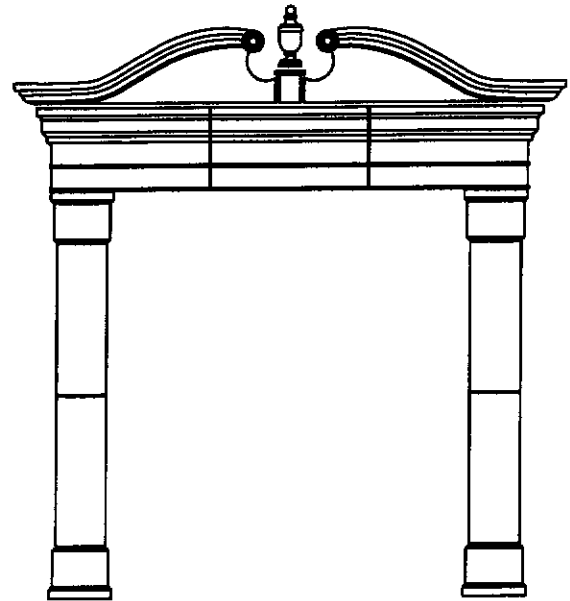

Inverness Entry

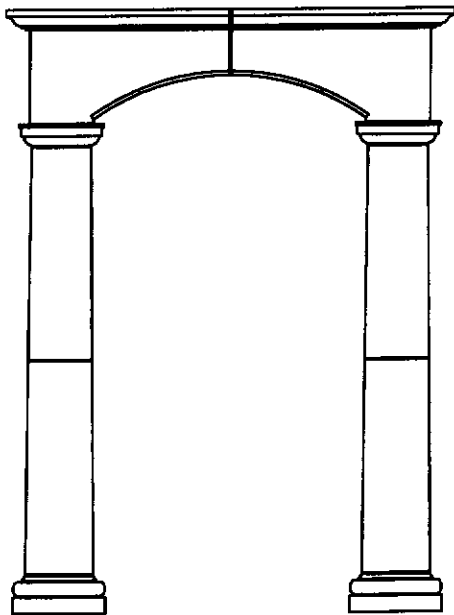

Inverness II Entry

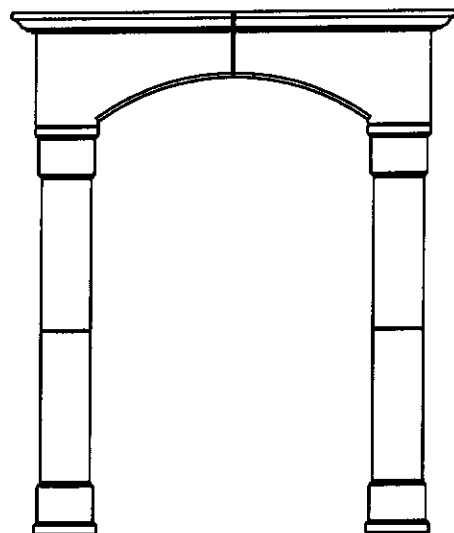

Phillip House Entry

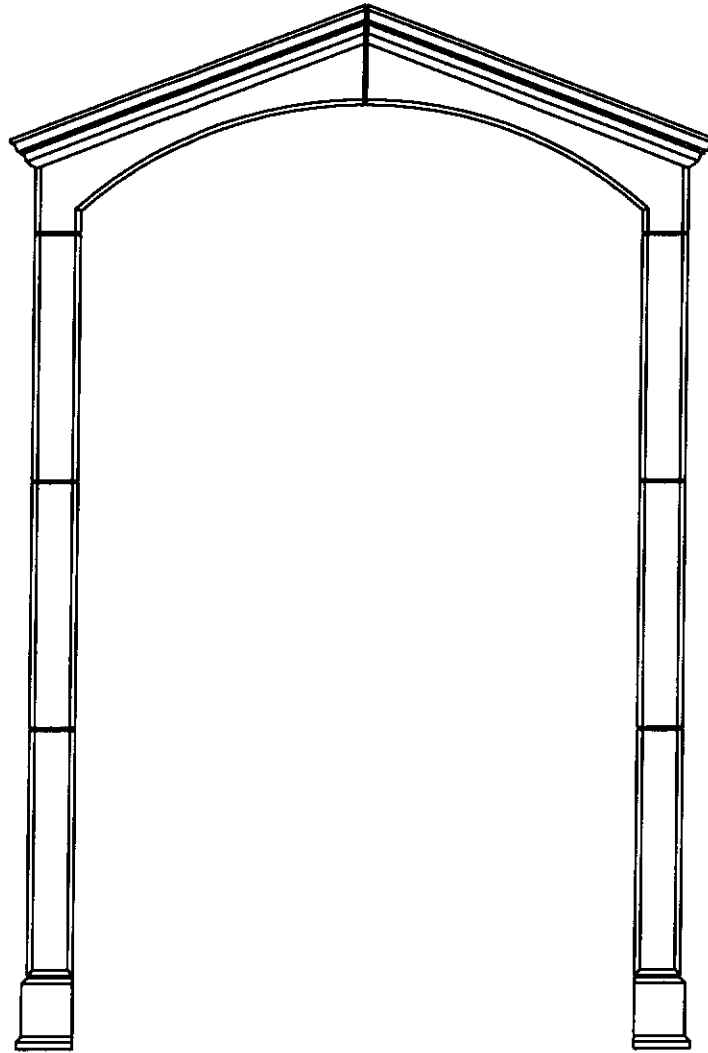

Note: Dimensions vary per application

Chamfered Sign Panel

ITEM NUMBER	"A"	"B"	"C"	"D"	"E"	"F"
CSCSP30	30"	15"	28-1/2"	13-1/2"	3-3/4"	3/4"
CSCSP78	78"	22"	76-1/2"	20-1/2"	2-1/4"	3/4"
CSCSP96	96"	30"	94-1/2"	28-1/2"	3-1/4"	3/4"

** NOT LIMITED TO THESE SIZES ASK FOR AVAILABILITY

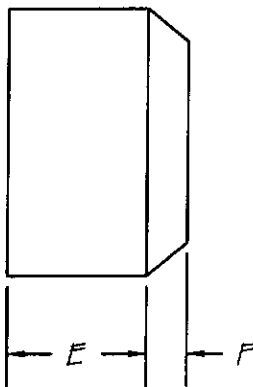
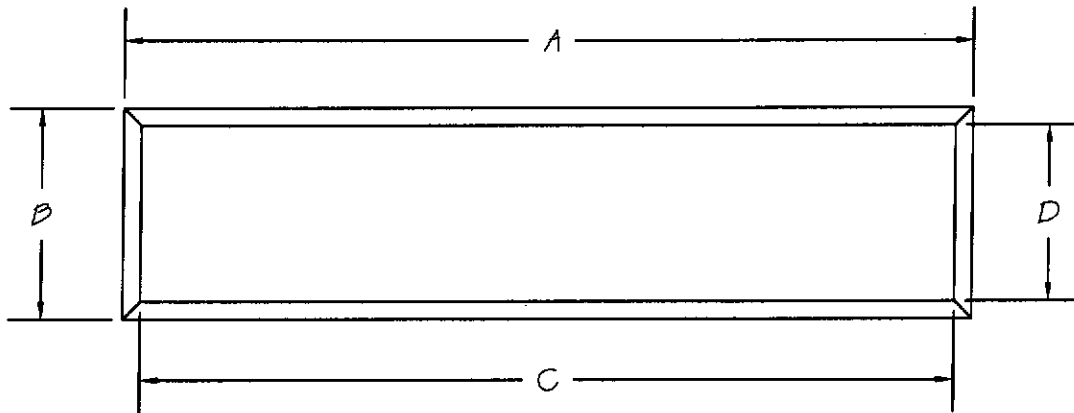

Flat Sign Panel

ITEM NUMBER	"A"	"B"	"C"	"D"	"E"	"F"
CSFSP57	57"	25-1/2"	3"	-	-	-
CSFSP72	72"	48"	4"	-	-	-
CSFSP78	78"	20"	4"	-	-	-

**** NOT LIMITED TO THESE SIZES ASK FOR AVAILABILITY**

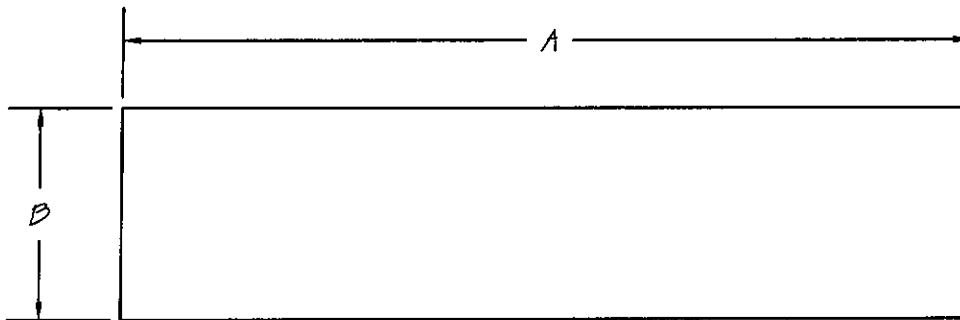

Recessed Sign Panel

ITEM NUMBER	"A"	"B"	"C"	"D"	"E"	"F"
CSRSP24	24"	15"	18-1/2"	9-1/2"	3-1/4"	3/4"
CSRSP27	27"	18"	21-1/2"	12-1/2"	3-1/4"	3/4"
CSRSP31	31"	13"	29"	11"	3-1/4"	3/4"
CSRSP60	60"	36"	44-1/2"	30-1/2"	3-1/4"	3/4"
CSRSP96S	96"	18"	91"	15"	3-1/4"	3/4"
CSRSP96M	96"	36"	90-1/2"	30-1/2"	3-1/4"	3/4"
CSRSP96L	96"	48"	90-1/2"	42-1/2"	3-1/4"	3/4"

** NOT LIMITED TO THESE SIZES ASK FOR AVAILABILITY

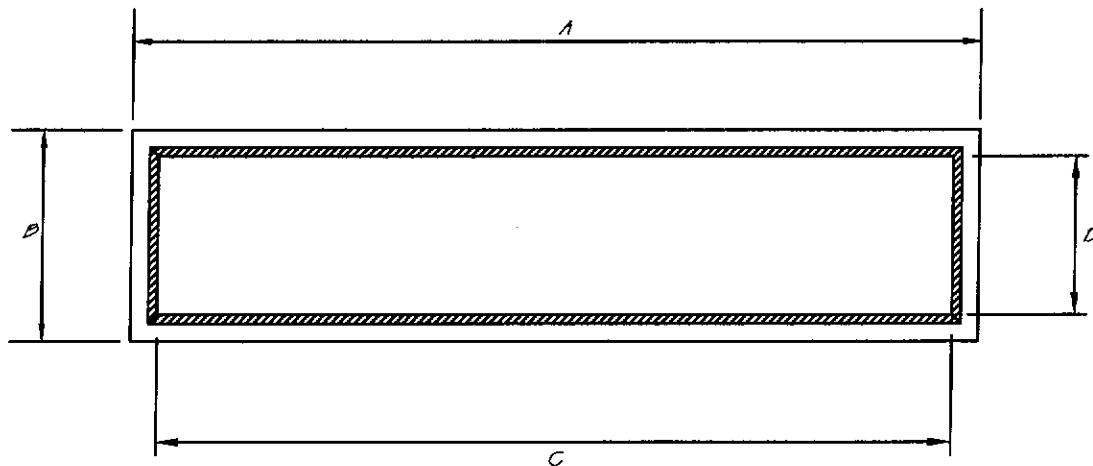

Standard Window Sill

ITEM NUMBER	"A"	"B"	"C"	"D"	"E"	"F"
CSSWS1018W	VARIABLE	6-3/4"	3-1/8"	4"	3"	1-7/8"

** NOTE: PIECES ARE AVAILABLE IN LENGTHS UP TO 36" IN LONG

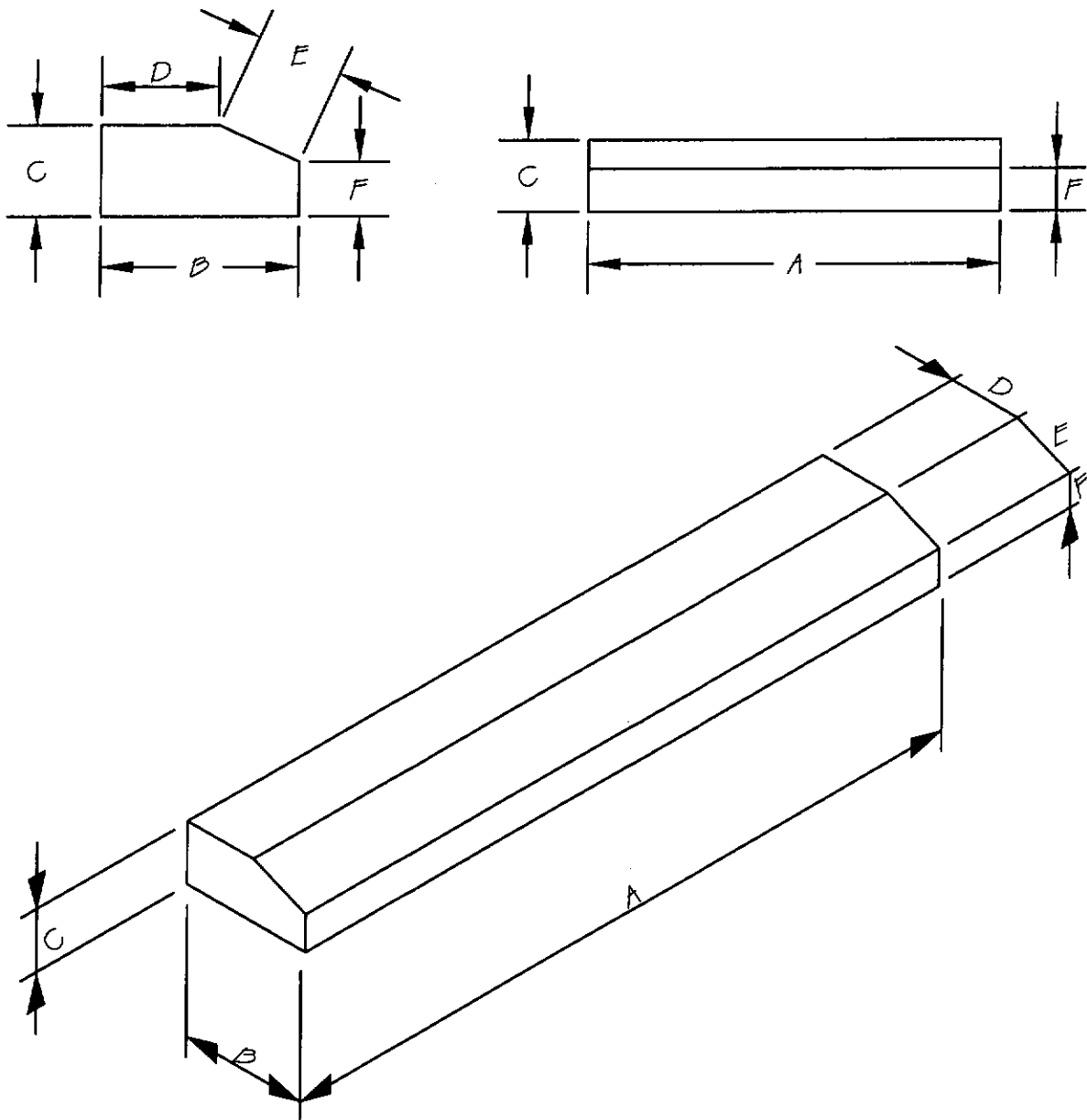

Walnut Hill

ITEM NUMBER	"A"	"B"	"C"	"D"
CSF1	-	-	-	-

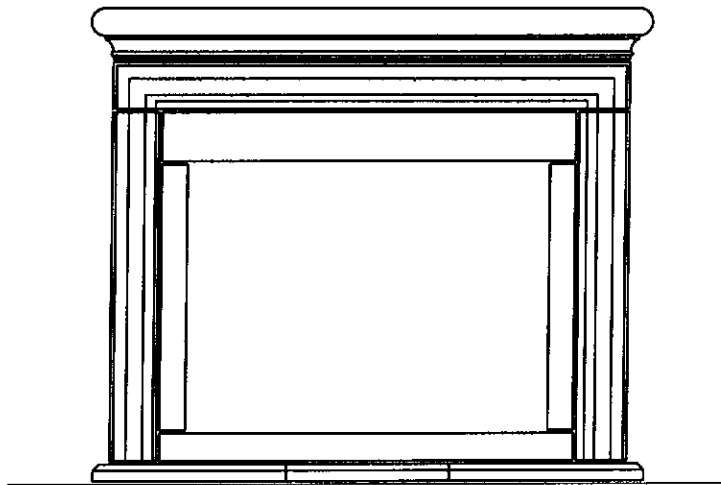

Elevation

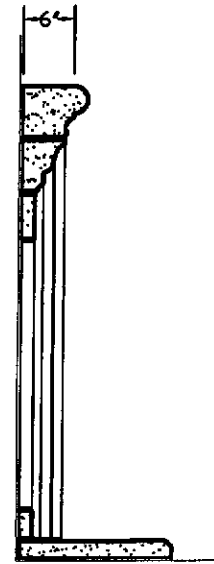

Section

Oak Wood

ITEM NUMBER	"A"	"B"	"C"	"D"
CSF2	-	-	-	-

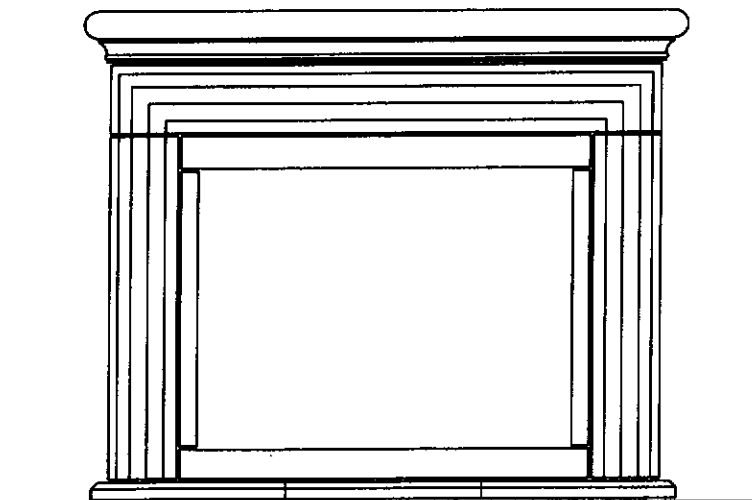

Elevation

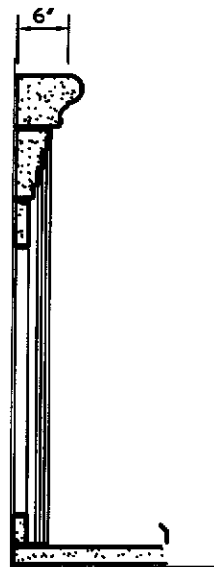

Section

Spring Hill

ITEM NUMBER	"A"	"B"	"C"	"D"
CSF3	-	-	-	-

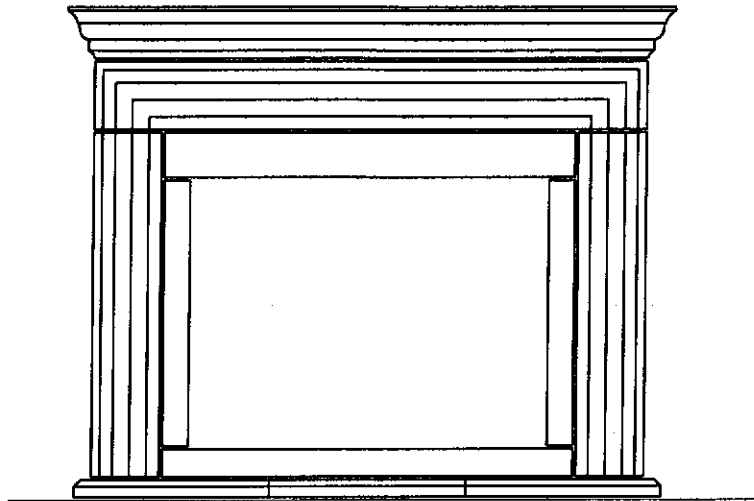

Elevation

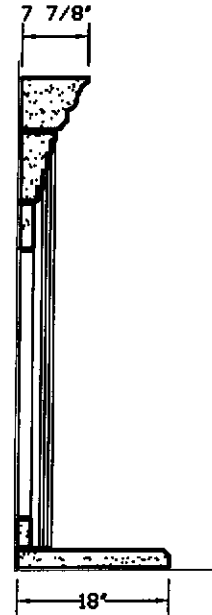

Section

Briar Glenn

ITEM NUMBER	"A"	"B"	"C"	"D"
CSF4	-	-	-	-

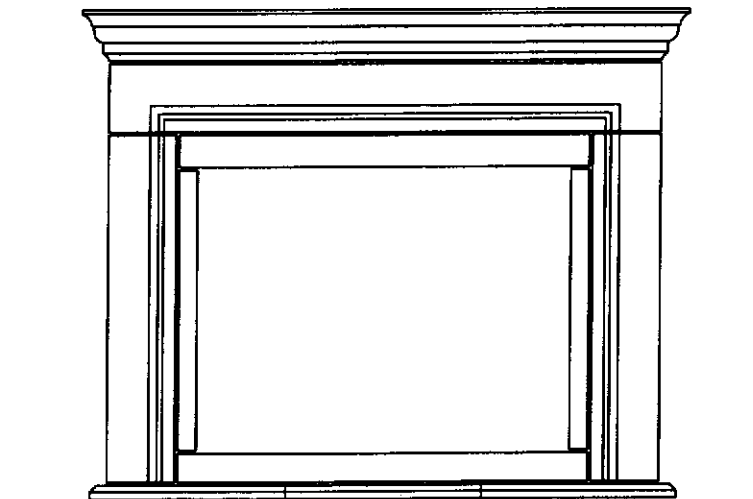

Elevation

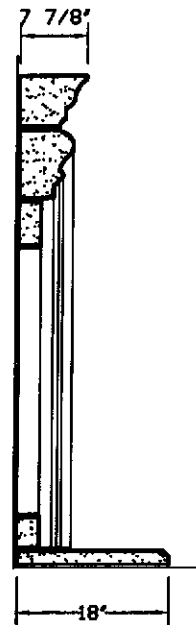

Section

Oak Glenn

ITEM NUMBER	"A"	"B"	"C"	"D"
CSF5	-	-	-	-

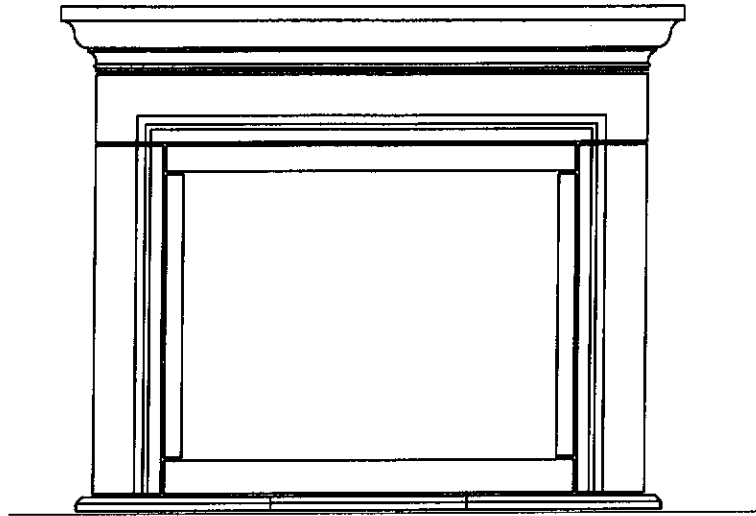

Elevation

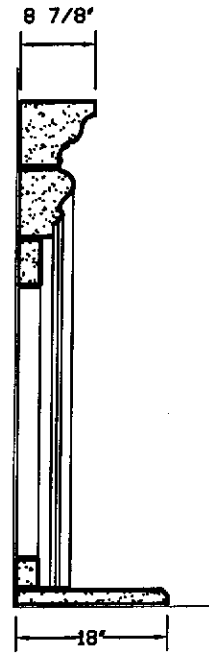

Section

Window Sill

ITEM NUMBER	"A"	"B"	"C"	"D"	"E"	"F"
CSWS5466	54"	6"	6"	-	-	-

